

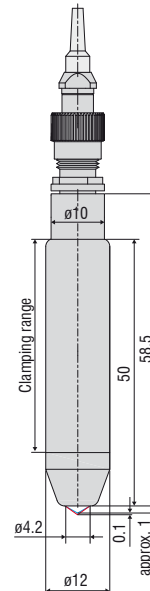

More Precision

confocalDT // Confocal chromatic sensor system

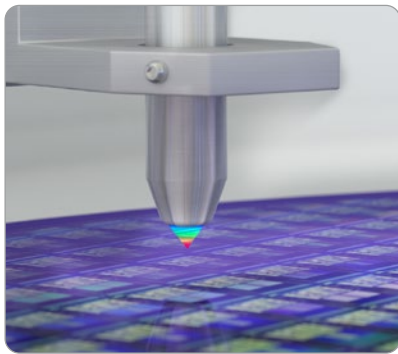

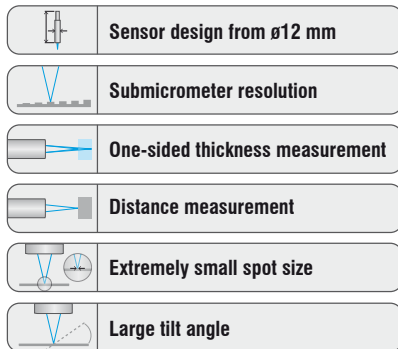

Dimensions in mm, not to scale

Model	IFS2407-0.1	IFS2407-0.1(001)
Measuring range	0.1 mm	0.1 mm
Start of measuring range	approx. 1 mm	1 mm
Resolution	static ¹⁾	3 nm
	dynamic ²⁾	6 nm
Linearity ³⁾	Displacement and distance	< ±0.05 μm
	Thickness	< ±0.1 μm
Light spot diameter	3 μm	4 μm
Max. tilt angle ⁴⁾	±48°	±48°
Numerical aperture (NA)	0.80	0.70
Min. target thickness ⁵⁾	0.005 mm	0.005 mm
Connection	pluggable optical fiber via FC socket, standard length 3 m; extension up to 50 m; bending radius: static 30 mm; dynamic 40 mm	
Installation	Clamping, mounting adapter (see accessories)	
Temperature range	Storage	-20 ... +70 °C
	Operation	+5 ... +70 °C
Shock (DIN EN 60068-2-27)	15 g / 6 ms in XY axis, 1000 shocks each	
Vibration (DIN EN 60068-2-6)	2 g / 20 ... 500 Hz in XY axis, 10 cycles each	
Protection class (DIN EN 60529)	IP65 (front)	
Material	Stainless steel housing, glass lenses	
Weight	approx. 36 g	approx. 36 g
Features	Sensor with high numerical aperture	Light-intensive sensor

¹⁾ Average from 512 values at 1 kHz, near to the midrange onto optical flat

²⁾ RMS noise relates to mid of measuring range (1 kHz)

³⁾ All data at constant ambient temperature (25 ± 1 °C) against optical flat; specifications can change when measuring different objects.

⁴⁾ Maximum sensor tilt angle that produces a usable signal on reflecting surfaces. The accuracy decreases when approaching the limit values.

⁵⁾ Glass with refractive index n = 1.5 throughout the entire measuring range. In the mid of the measuring range, also thinner layers can be measured.

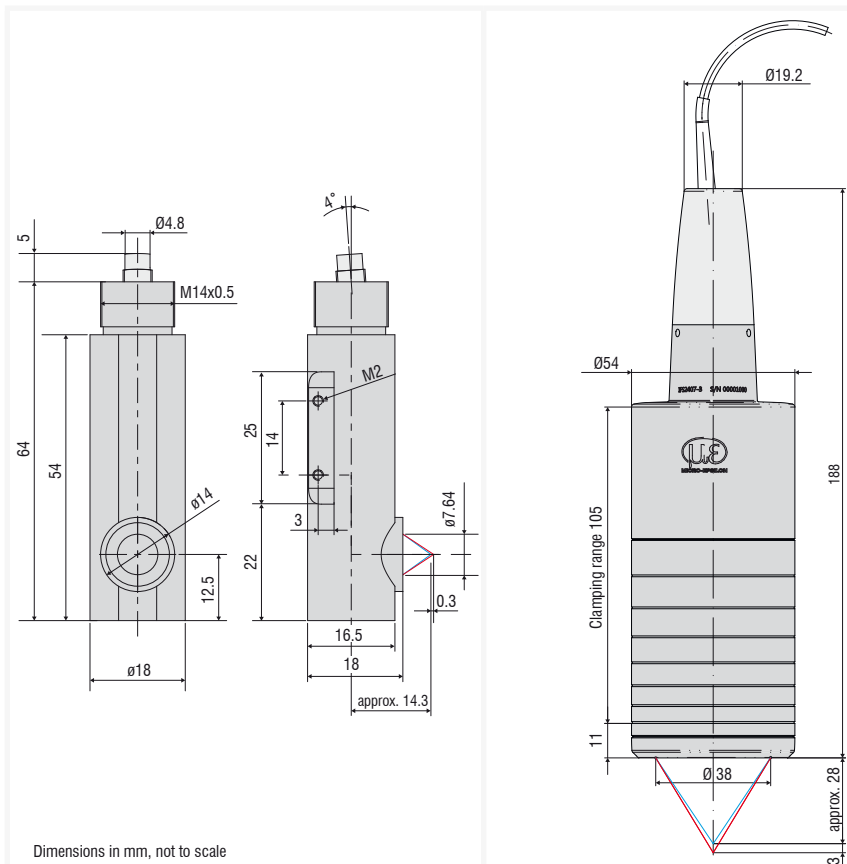

Model	IFS2407/90-0,3		IFS2407-3	
Measuring range	0.3 mm		3 mm	
Start of measuring range	approx.	5.3 mm	28 mm	
Resolution	static ¹⁾	10 nm	20 nm	
	dynamic ²⁾	20 nm	58 nm	
Linearity ³⁾	Displacement and distance	< ±0.15 μm	< ±0.75 μm	
	Thickness	< ±0.3 μm	< ±1.5 μm	
Light spot diameter	6 μm		9 μm	
Max. tilt angle ⁴⁾	±27°		±30°	
Numerical aperture (NA)	0.50		0.53	
Min. target thickness ⁵⁾	0.015 mm		0.15 mm	
Connection	pluggable optical fiber via FC socket, type C2407-x; standard length 3 m; extension up to 50 m; bending radius: static 30 mm, dynamic 40 mm		pluggable optical fiber via FC socket, standard length 3 m; extension up to 50 m; bending radius: static 30 mm, dynamic 40 mm	
Installation	Mounting holes (2x M2)		Clamping, mounting adapter (see accessories)	
Temperature range	Storage	-20 ... +70 °C		
	Operation	+5 ... +70 °C		
Shock (DIN EN 60068-2-27)	15 g / 6 ms in XY axis, 1000 shocks each			
Vibration (DIN EN 60068-2-6)	2 g / 20 ... 500 Hz in XY axis, 10 cycles each			
Protection class (DIN EN 60529)	IP65 (front)			
Material	Stainless steel housing, glass lenses		Aluminum housing, glass lenses	
Weight	approx. 30 g		approx. 550 g	

¹⁾ Average from 512 values at 1 kHz, near to the midrange onto optical flat

²⁾ RMS noise relates to mid of measuring range (1 kHz)

³⁾ All data at constant ambient temperature (25 ±1 °C) against optical flat; specifications can change when measuring different objects.

⁴⁾ Maximum sensor tilt angle that produces a usable signal on reflecting surfaces. The accuracy decreases when approaching the limit values.

⁵⁾ Glass with refractive index n = 1.5 throughout the entire measuring range. In the mid of the measuring range, also thinner layers can be measured.

System design

The confocalDT system consists of:

- Sensor IFS240x
- Controller IFC24xx
- Fiber optic cable C24xx

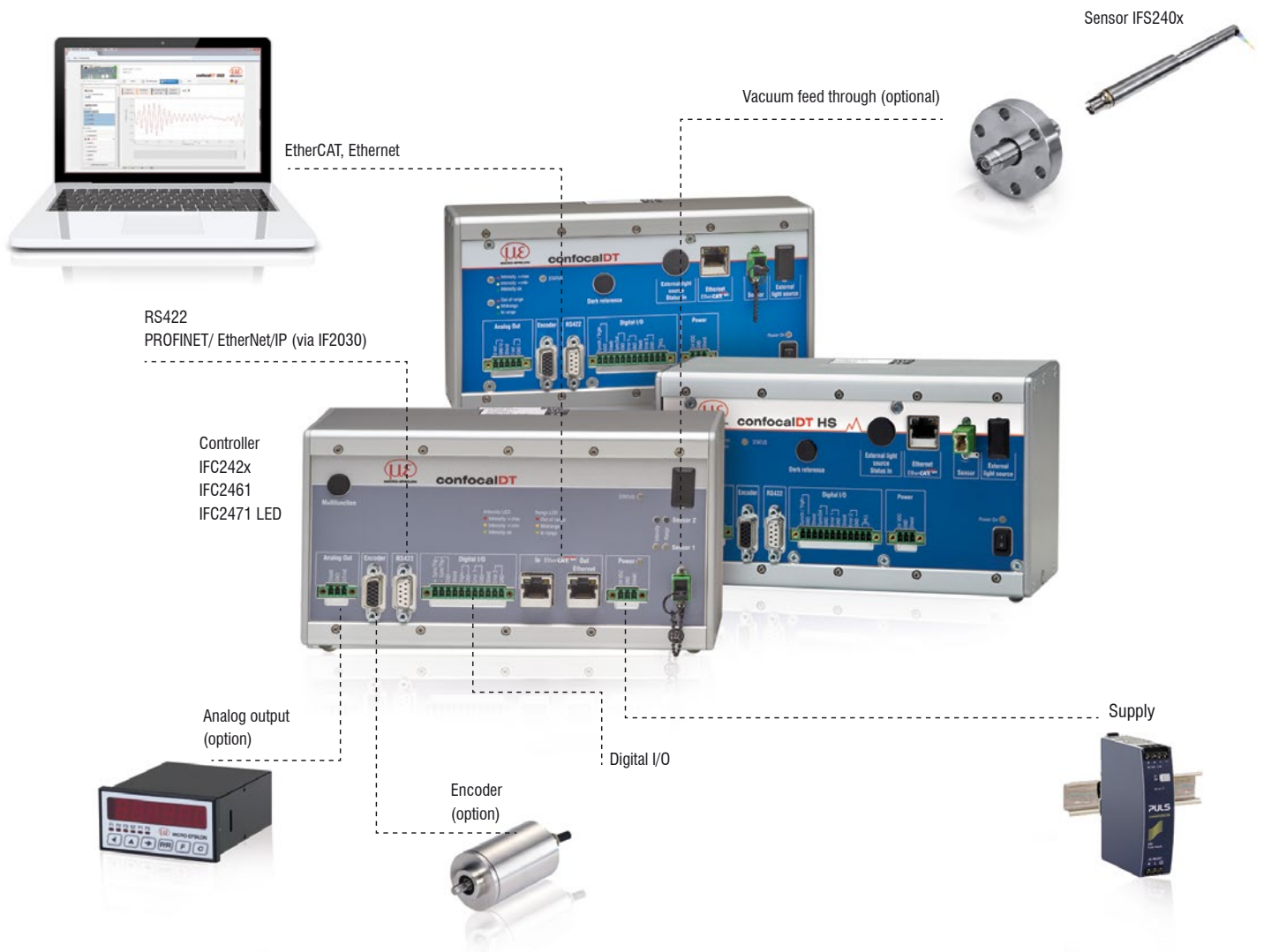

Customer-specific modifications

Application examples are often found where the standard versions of the sensors and the controllers are performing at their limits. To facilitate such special tasks, it is possible to customize the sensor design and to adjust the controller accordingly. Common requests for modifications include changes in design, mounting options, customized cable lengths and modified measuring ranges.

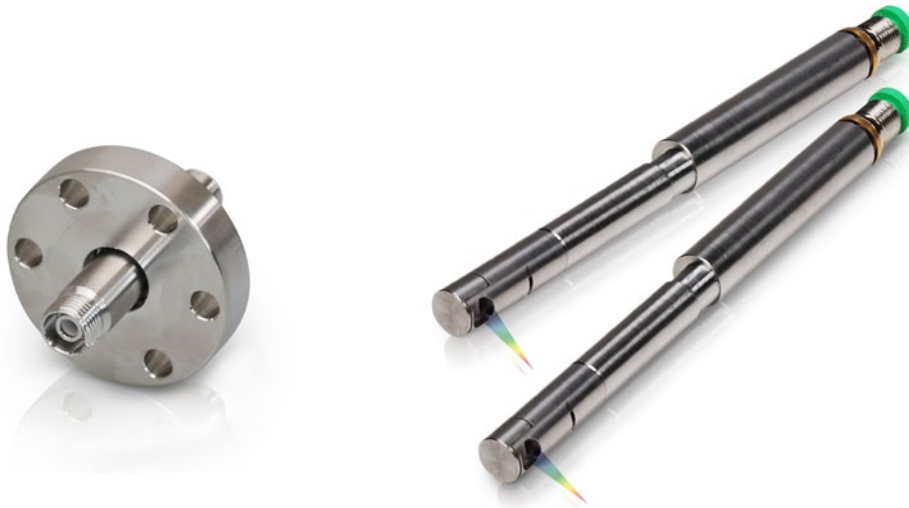

Possible modifications

- Sensors with connector
- Cable length
- Vacuum suitability up to UHV
- Specific lengths
- Customer-specific mounting options
- Optical filter for ambient light compensation
- Housing material
- Measuring range / Offset distance

Vacuum setup

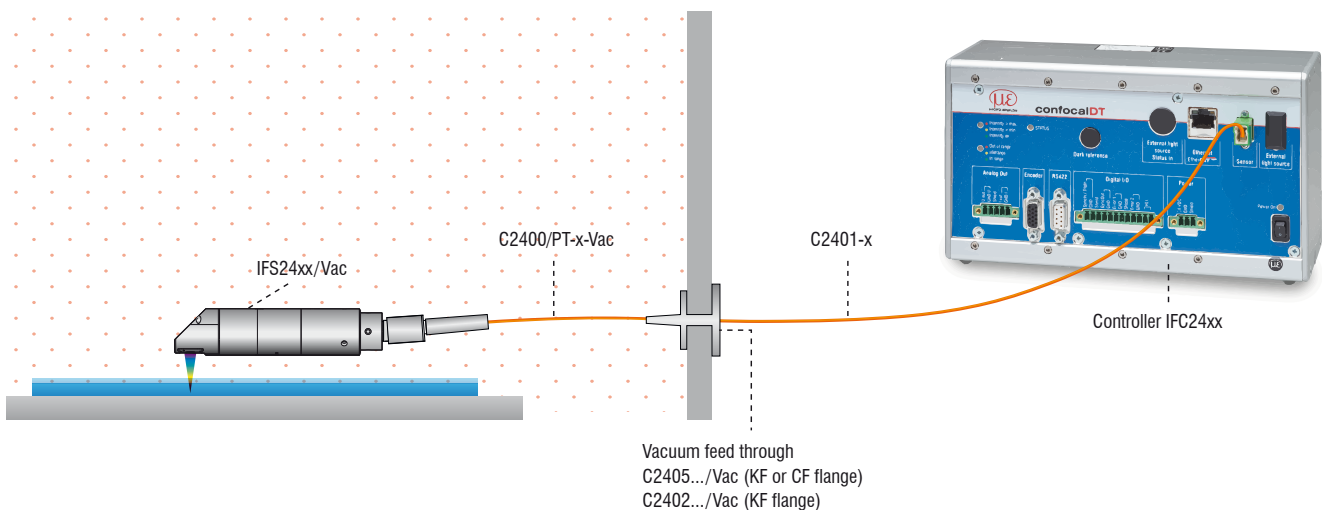

Accessories: mounting adapter
MA2402 for sensors 2402

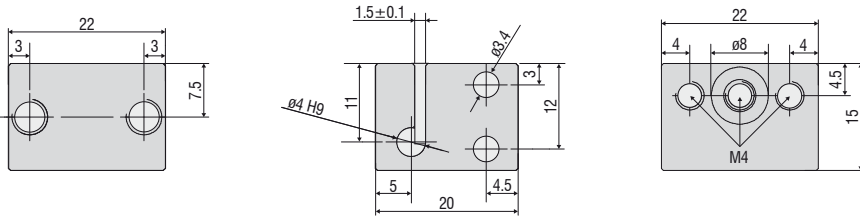

Accessories: mounting adapter
MA2403 for sensors 2403

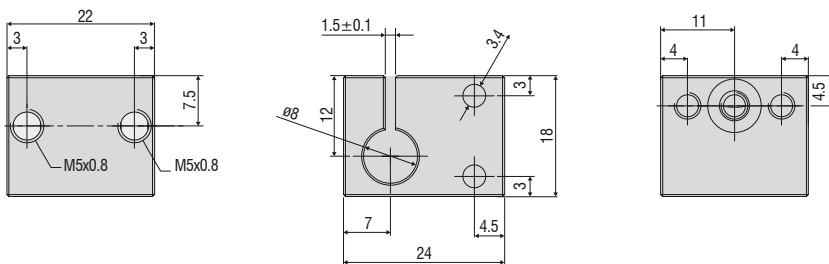

Accessories: mounting adapter
MA2404-12 for sensors IFS2404-2 / IFS2404/90-2 / IFS2407-0,1

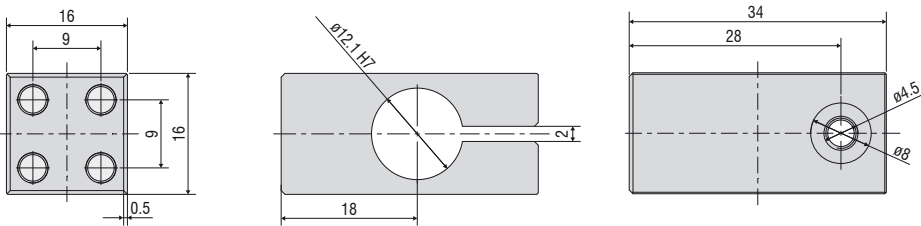

Accessories: mounting adapter
MA2400 for sensors IFS2405 / IFS2406 / IFS2407 (consisting of a mounting block and a mounting ring)

Mounting block

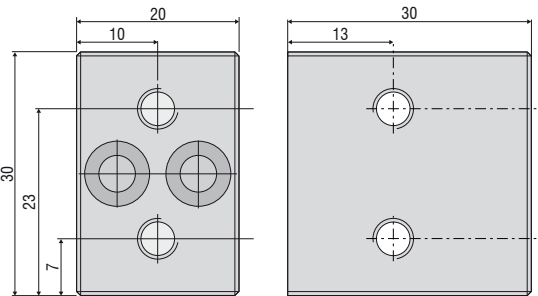

Mounting ring

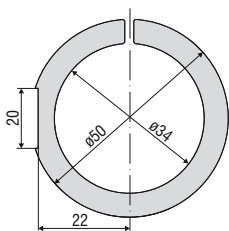
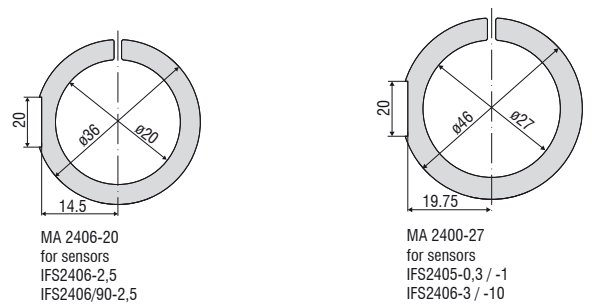

MA 2405-34
for sensors
IFS2405-3

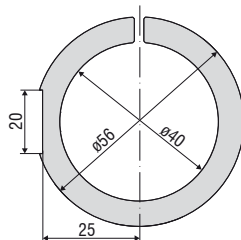

MA 2405-40
for sensors
IFS 2405-6

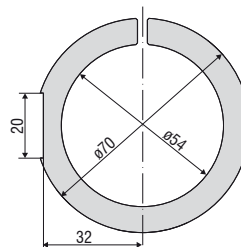

MA 2405-54
for sensors
IFS2405-10 / IFS2407-3

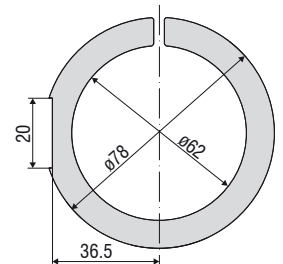

MA 2405-62
for sensors
IFS2405-28 / -30

Accessories

Software

IFD24xx-Tool Software demo tool included

Accessories light source

IFL2422/LE Lamp module for IFC2422

IFL24x1/LED Lamp module for IFC24x1

Cable extension for sensors

CE2402 cable with 2x E2000/APC connectors

CE2402-x Extension for optical fiber (3 m, 10 m, 13 m, 30 m, 50 m)

CE2402-x/PT Extension for optical fiber with protection tube for mechanical stress (3 m, 10 m, customer-specific length up to 50 m)

Cable for IFS2404 sensors

C2404-x Optical fiber with FC/APC and E2000/APC connectors
Fiber core diameter 20 μm (2 m)

Cables for IFS2405/IFS2406/2407-0,1 sensors

C2401 cable with FC/APC and E2000/APC connectors

C2401-x Optical fiber (3 m, 5 m, 10 m, customer-specific length up to 50 m)

C2401/PT-x Optical fiber with protection tube for mechanical stress (3 m, 5 m, 10 m, customer-specific length up to 50 m)

C2401-x (01) Optical fiber core diameter 26 μm (3 m, 5 m, 15 m)

C2401-x(10) Drag-chain suitable optical fiber (3 m, 5 m, 10 m)

C2400 cable with 2x FC/APC connectors

C2400-x Optical fiber (3 m, 5 m, 10 m, customer-specific length up to 50 m)

C2400/PT-x Optical fiber with protection tube for mechanical stress (3 m, 5 m, 10 m, customer-specific length up to 50 m)

C2400/PT-x-Vac Optical fiber with protection tube suitable for use in vacuum (3 m, 5 m, 10 m, customer-specific length up to 50 m)

Cable for IFS2407/90-0,3 sensors

C2407-x Optical fiber with DIN connector and E2000/APC (2 m, 5 m)

Vacuum feed through

C2402/Vac/KF16 Vacuum feed through with optical fiber, 1 channel, vacuum side FC/APC non-vacuum side E2000/APC, clamping flange KF 16

C2405/Vac/1/KF16 Vacuum feed through on both sides FC/APC socket, 1 channel, clamping flange type KF 16

C2405/Vac/1/CF16 Vacuum feed through on both sides FC/APC socket, 1 channel, flange type CF 16

C2405/Vac/6/CF63 Vacuum feed through FC/APC socket, 6 channels, flange type CF 63

Other accessories

SC2471-x/USB/IND Connector cable IFC2461/71, 3 m, 10 m, 20 m

SC2471-x/IF2008 Connector cable IFC2461/71-IF2008, 3 m, 10 m, 20 m

PS2020 Power supply 24V / 2.5A

EC2471-3/OE Encoder cable, 3m

IF2030/PNET Interface module for PROFINET connection

IF2030/ENETIP Interface module for EtherNet/IP connection

Optical fiber

Temperature range : -50 °C to 90 °C

Bending radius: 30/40 mm

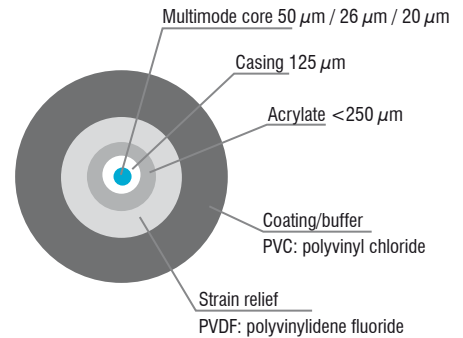

E2000/APC standard connector

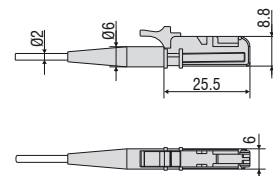

FC/APC standard connector

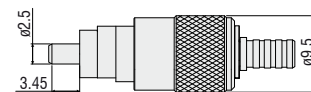

DIN connector

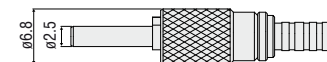

Sensors and Systems from Micro-Epsilon



Sensors and systems for displacement, distance and position



Sensors and measurement devices for non-contact temperature measurement



Measuring and inspection systems for metal strips, plastics and rubber



Optical micrometers and fiber optics, measuring and test amplifiers



Color recognition sensors, LED analyzers and inline color spectrometers

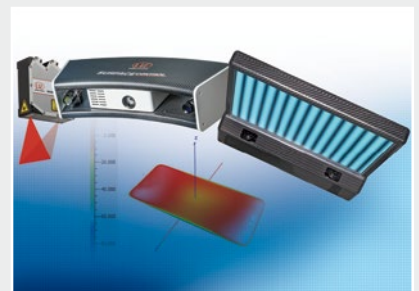

3D measurement technology for dimensional testing and surface inspection