



# More Precision

optoNCDT ILR // Laser-optical distance sensors





- Measuring range up to 15 m onto diffuse reflecting surfaces, 50 m onto reflector
- Fast response time
- Compact design
- Excellent price/performance ratio
- IP67

The ILR103x/LC1 laser distance sensors operate according to the time-of-flight technology. Based on this technology, these sensors provide accurate, reliable and unambiguous as well as reproducible measurement results regardless of ambient conditions such as surface properties, dark colors or ambient light. The sensors use a measuring laser with laser class 1.

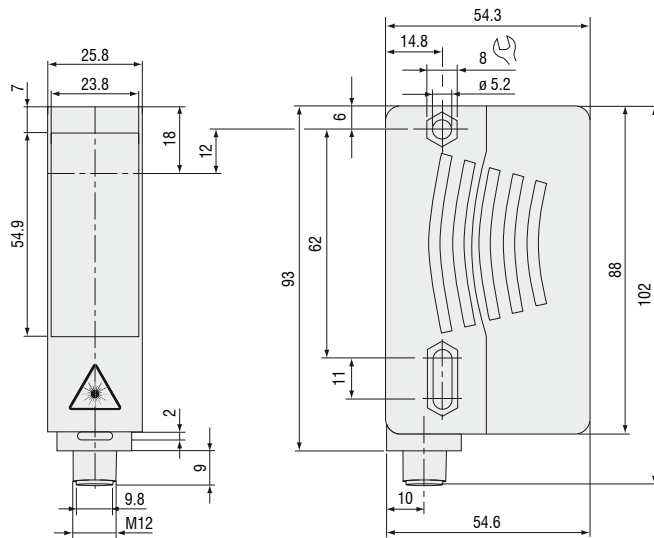

ILR103x: Adjust analog output and switching output via touch keys

Model	ILR1030-8/LC1	ILR1030-15/LC1	ILR1031-50/LC1
Article number	7112011.01	7112013.01	7112012.01
Measuring range <sup>1)</sup>	black 10%	0.2 ... 2.5 m	0.2 ... 5 m
	gray 18%	0.2 ... 3.5 m	0.2 ... 6 m
	white 90%	0.2 ... 8 m	0.2 ... 15 m
	Reflector	-	-
Repeatability	<3 mm		
Resolution	1 mm		
Linearity <sup>2)</sup>	< ±20 mm		
Measurement frequency	100 Hz		
Light source	semiconductor laser (red 660 nm)		
Laser safety class	EN 60825-1:2007	Class 1	
Divergence	< 1.5 mrad		
Permissible ambient light	50,000 lx		
Operating temperature <sup>3)</sup>	-30 ... +55 °C (humidity 5 ... 95 %, non-condensing)		
Storage temperature	-30 ... +70 °C		
Switching output	Q1/Q2 push-pull outputs		
Switching voltage	max. 30 VDC		
Switching current	max. 100 mA		
Analog output	4 ... 20 mA (12 bit DA), short-circuit/overload protected		
Temperature stability	≤ 0.25 mm / °C		
Power supply	10 ... 30 VDC, class 2		
Connection	4-pin, M12		
Protection class	IP67		
Material	Housing	ABS plastics	
	Window	plastic pane	
Weight	90 g		
EMC	complies with 2014/30/EU		
Accessories	page 10		

<sup>1)</sup> Depending on target reflectance, ambient light influences and atmospheric conditions

<sup>2)</sup> Statistical spread of 95% over the entire measuring range

<sup>3)</sup> When crossing 0 °C additional heating may be required

#### Spot diameter ILR103x/LC1



The ILR103x/LC1 sensors use a semiconductor laser of class 1.

Laser class 1 devices require no special safety precautions.

They work with a semi-conductor laser with a wavelength of 660 nm in the (visible/red)

Laser power is <1 mW.

## Accessories

## Supply and output cable for ILR10xx series

Art. no.	Designation	
2901232	PC1000-2	Length 2 m
2901233	PC1000/90-2	Length 2 m, 90° connector
2901234	PC1000-5	Length 5 m
2901235	PC1000/90-5	Length 5 m, 90° connector
29011248	PC1000-10	Length 10 m
2901268	PC1000/90-10	Length 10 m, 90° connector

## Supply and output cable ILR11xx

Art. no.	Designation	
2901524	PC1100-3	Length 3 m
2901239	PC1100/90-3	Length 3 m, 90° connector
2901573	PC1100-5	Length 5 m
2901235	PC1100/90-5	Length 5 m, 90° connector
2901236	PC1100/10	Length 10 m
2901241	PC1100/90-10	Length 10 m, 90° connector
2901237	PC1100/20	Length 20 m
2901242	PC1100/90-20	Length 20 m, 90° connector
2901238	PC1100/30	Length 30 m
2901243	PC1100/90-30	Length 30 m, 90° connector
0323241	FC1100	Cable connector
0323242	FC1100/90	Cable connector, 90° (angled)
2901551	PC1100/90-3/RS232	Length 3 m, 90° connector, RS232

## Profibus

Art. no.	Designation	
2901435	PBC1100-I/O-5	Profibus input and output cable, 5 m
2901436	PBC1100-I-5	Profibus input cable, 5 m
2901437	PBC1100-I-10	Profibus input cable, 10 m
2901438	PBC1100-O-5	Profibus output cable, 5 m
2901439	PBC1100-O-10	Profibus output cable, 10 m
0323310	PBFC1100	Profibus socket
0323311	PBMC1100	Profibus plug
0323312	PBLR1100	Profibus terminating resistor

## Accessories for ILR10xx series

Art. no.	Designation	
7966001	ILR-RF250	Reflector film 250 x 250 mm
7966002	ILR-R250	Reflector 250 x 250 mm

## Accessories for ILR 118x / 1191 series

Art. no.	Designation	
7966014	ILR-MP1191	Mounting plate for ILR1191
7966052	ILR aligning aid for ILR1191	Aligning aid for ILR1191
7966016	ILR-PT1191	Protection tube, 100 mm for ILR1191
7966019	ILR-RF118x	Reflector film 250 x 250 mm for ILR118x
7966020	ILR-MT118x	Mounting clamp for ILR118x
7966025	ILR-MP118x	Mounting plate for ILR118x
7966021	ILR-MTN118x	Slot nuts for ILR118x
7966022	ILR-FBV118x	Air purge collar for ILR118x
7966023	ILR-PG118x	Protective glass for ILR118x
7966024	ILR-FV118x	Filter adapter for ILR118x
2213025	IF2001/USB	RS422/USB converter

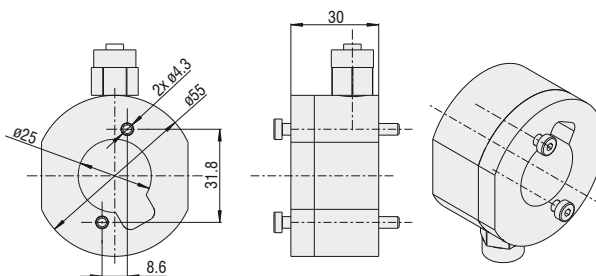

ILR-FBV118x air purge collar for ILR118x

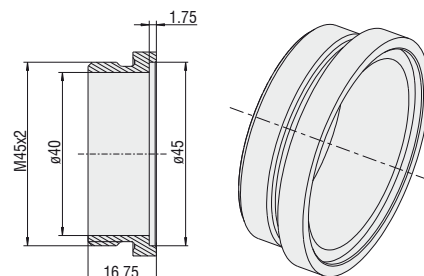

ILR-PG118x protection glass for ILR118x

**Free setup and configuration software**

The scope of supply includes software for easy sensor configuration. The settings can be implemented conveniently via a Windows user interface on the PC. The sensor parameters are transmitted to the sensor via the serial port and can also be saved if required. The software also contains a module which can display and store the measurement results. The sensor is connected to the PC via the sensor cable using a USB converter.

**Free download**

Download free of charge from [www.micro-epsilon.com/download](http://www.micro-epsilon.com/download): software and driver for easy sensor integration in existing software.

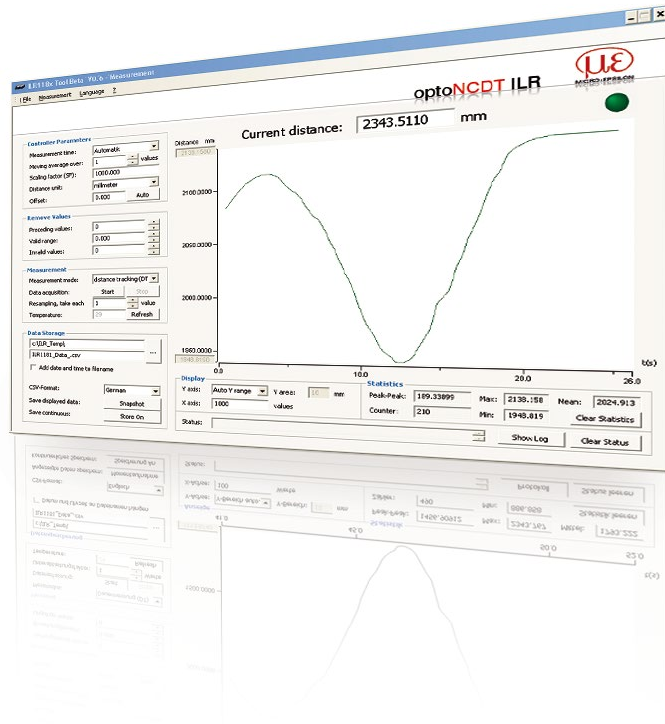

**Applications**



**Position measurement on gantry cranes**  
Gantry cranes require multiple measurement tasks: Positioning of the trolley, detection and dimensioning of containers and monitoring of the minimum clearance between the cranes. The ILR1191 with a very large measuring range and low response time is designed for these measurement tasks.

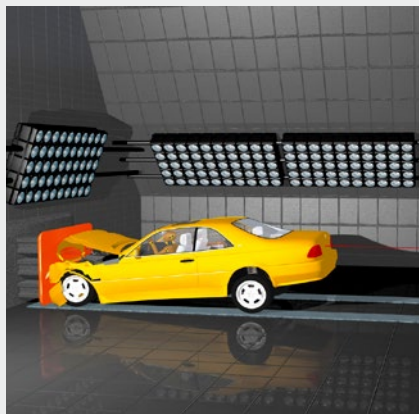

**Crash test speed measurement**  
At acceleration of cars during crash tests, an ILR1191 measures the impact speed and deformation of the test vehicle.

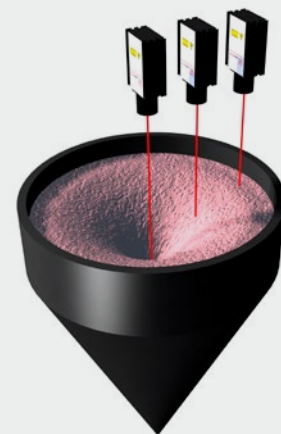

**Filling level measurement in silos**  
Depending on the required accuracy, laser distance sensors determine the filling level of silos at up to four points. Based on these distances, the filling level is calculated.

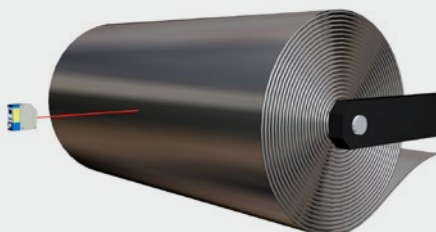

**Acquisition of coil diameters**  
The quantity of steel wound on and off is monitored via the acquisition of coil diameters using laser probes.

## Sensors and Systems from Micro-Epsilon



Sensors and systems for displacement, distance and position



Sensors and measurement devices for non-contact temperature measurement



Measuring and inspection systems for metal strips, plastics and rubber



Optical micrometers and fiber optics, measuring and test amplifiers



Color recognition sensors, LED analyzers and inline color spectrometers

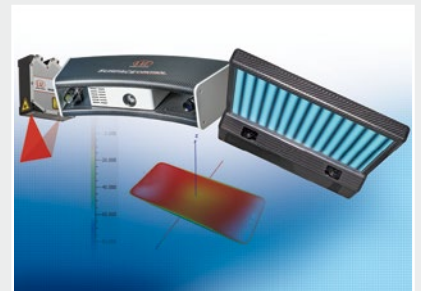

3D measurement technology for dimensional testing and surface inspection