



More Precision

thermo**IMAGER** TIM // Compact thermal imaging cameras





thermoIMAGER TIM M-05

Compact infrared camera for the short-wave range for non-contact temperature measurement of molten metal and metallic surfaces from 900 °C to 2450 °C

- Highly dynamic CMOS detector with resolution up to 764 x 480 pixels
- Special wavelength range from 500 nm to 540 nm minimizes errors caused by unknown emissivity
- Wide measuring range from 900 °C to 2450 °C (without sub-ranges)
- Frame rates up to 1 kHz for fast processes
- Real-time analog output with 1 ms response time
- Comprehensive software package and SDK
- Ideally suitable for laser processing applications as radiation > 540 nm is perfectly blocked

Software

- Display of the thermal image in real time with recording function (video, snapshot)
- Complete set up of parameters and remote control of the camera
- Detailed analysis of fast, thermodynamic processes
- Output of analog temperature or alarm values via the process interface
- Digital communication via RS232 or DLL for software integration

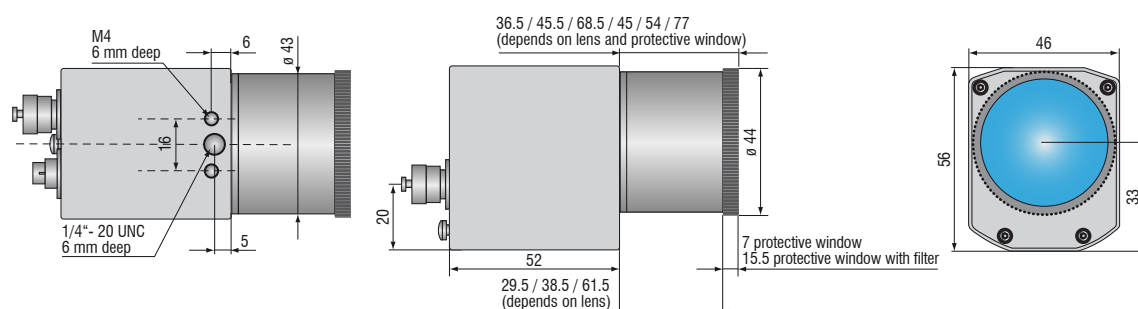
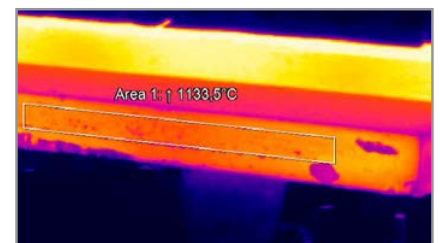
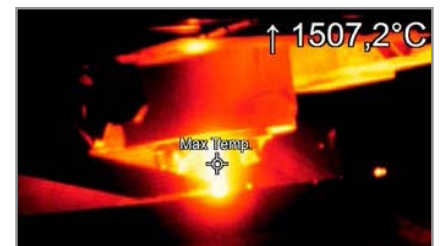
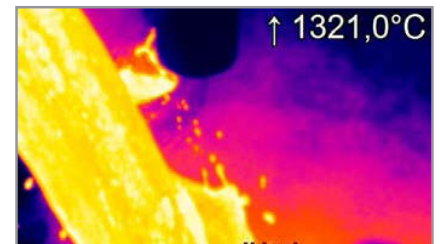

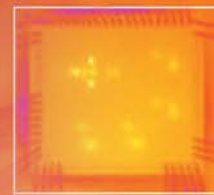

Model	TIM M-05	
Optical resolution	764 x 480 pixels @ 32 Hz 382 x 288 pixels @ 80 Hz (switchable to 27 Hz) 72 x 56 pixels @ 1 kHz ¹⁾ 764 x 8 pixels @ 1 kHz (fast line-scan mode) ¹⁾	
Temperature ranges	900 ... 2450 °C (27 Hz mode) 950 ... 2450 °C (32 Hz mode) 950 ... 2450 °C (80 Hz mode) 1100 ... 2450 °C (1 kHz mode)	
Spectral range	500 to 540 nm	
Frame rate	up to 1 kHz / 1 ms real-time analog output (0 - 10 V) from 8 x 8 pixels (freely selectable)	
System accuracy	± 1 % of reading (< 2000 °C) / ± 1.5 % of reading (> 2000 °C) ²⁾	
Lenses	FOV @ 764 x 480 px: 26° x 16° (f = 25 mm) ³⁾	FOV @ 382 x 288 px: 13° x 10° (f = 25 mm) ³⁾
Thermal sensitivity (NETD) ³⁾	< 2 K (< 1400 °C / 27 Hz to 1 kHz) ⁴⁾	
Detector	CMOS (15 µm x 15 µm)	
Outputs/digital	USB 2.0 / optional interface USB to GigE (PoE)	
High speed analog output (@ 1 kHz mode)	1 ms real-time analog output (0 - 10 V) from 8 x 8 pixels (freely selectable)	
Standard process interface (PIF)	0 - 10 V input, digital input (max. 24 V), 0 - 10 V output	
Industry process interface (PIF)	2x 0 - 10 V inputs, digital input (max. 24 V), 3x 0/4 - 20 mA outputs, 3x relays (0 - 30 V / 400 mA), fail-safe relay	
Cable length (USB)	1 m (standard), 5 m, 10 m, 20 m 5 m and 10 m also available as high temperature USB cable (180 °C or 250 °C)	
Power supply	USB powered	
Tripod mount	¼-20 UNC	
Protection class	IP67 ⁵⁾	
Ambient temperature	5 ... 50 °C	
Storage temperature	-40 ... 70 °C	
Relative humidity	20 to 80 %, non-condensing	
Vibration	IEC 60068-2-6 (sinus-shaped) / IEC 60068-2-64 (broadband noise)	
Shock	IEC 60068-2-27 (25 g and 50 g)	
Housing (size)	46 mm x 56 mm x 88 - 129 mm (depending on lens and focus position)	
Weight	245 - 311 g, incl. lens	

¹⁾ Can be placed anywhere within the FOV

²⁾ For 1 kHz mode: ± 1.5 % FSO (< 2000 °C) / ± 2 % FSO (> 2000 °C)

³⁾ Please note: measurement accuracy can be out of specification with distances below 500 mm

⁴⁾ < 4 K (> 1400 °C / 27 Hz to 1 kHz)

⁵⁾ Only applies when lens protection tube is used

Scope of supply

TIM M-05

- TIM process camera
incl. a selectable lens
- Lens cap incl. protective window
- Operating instructions
- USB cable 1 m
- Software for real-time processing
and analyzing thermal images
- Tripod mount
- PIF cable incl. terminal block (1 m)
- Transport case
- Optional: Cooling Jacket Advanced,
high temperature cable

TIMConnect SOFTWARE FEATURES

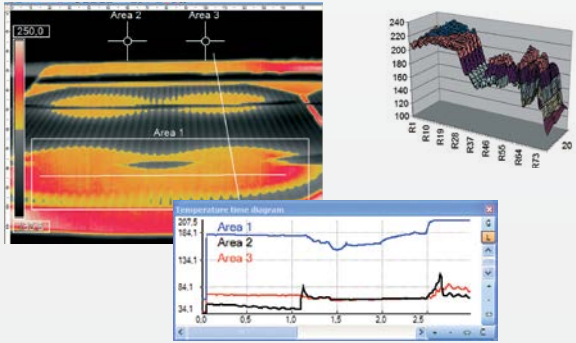

Comprehensive IR camera software

- License-free analysis software and complete SDK included
- Intuitive user interface
- Camera remote control via software
- Displays several camera images in different windows
- Compatible with Windows 7, 8 and 10
- Data output via PIF hardware interface using up to 3 analog channels

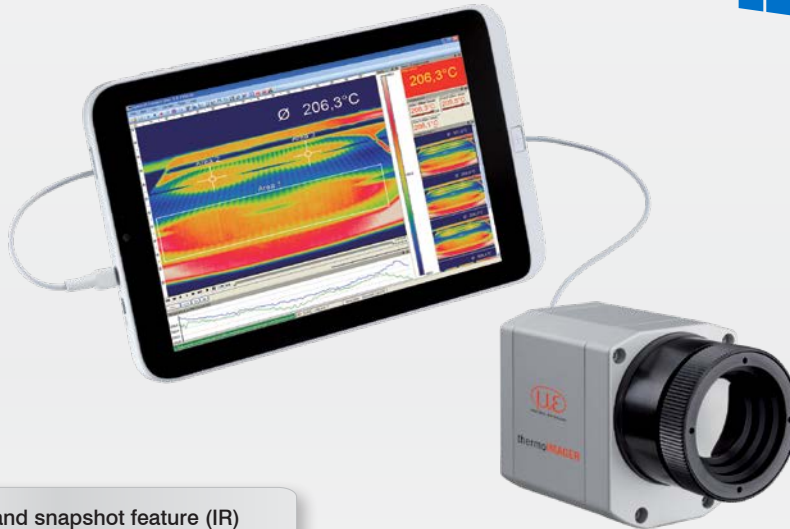

Video recording and snapshot feature (IR)

- Recording of video sequences and individual images for later analysis or documentation
- Adjustable frame rate to reduce data volume
- Display of snapshot process for direct analysis

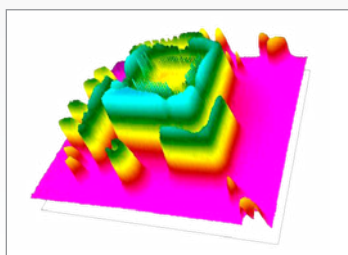
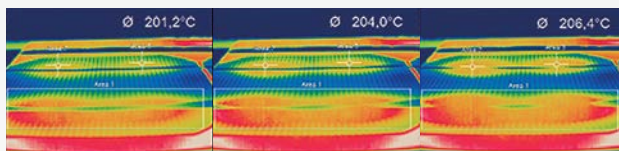

Online and offline data analysis

- Real-time temperature information (°C or °F) in main window, as digital display or graphic display
- Detailed analysis using measuring fields, automatic hotspot/coldspot search
- Logical linking of temperature information
- Slow-motion replay without connected camera
- Various layout functions and color palettes to highlight thermal contrasts

Temperature data analysis and documentation

- Triggered data collection
- Radiometric video sequences (*.ravi) and snapshots (*.tiff)
- Thermal images as *.tiff or *.csv, *.dat text files incl. complete temperature information
- Data transfer in real time to other software programs via DLL or COM port interfaces

Lenses thermoIMAGER TIM M-1 / TIM M-08 / TIM M-05

TIM M-1 / TIM M-08 ¹⁾ / TIM M-05 ¹⁾	Focal length [mm]	Angle	Minimum measurement distance*	Distance to measurement object [m]											
					0.1	0.2	0.3	0.5	1	2	4	6	10	30	100
382 x 288 px	16	20° 15° 25° 0.94 mrad	0.2 m	HFOV [m]		0.07	0.11	0.18	0.36	0.72	1.43	2.15	3.6	10.7	35.8
				VFOV [m]		0.05	0.08	0.14	0.27	0.54	1.08	1.62	2.7	8.1	27.0
				DFOV [m]		0.09	0.13	0.22	0.45	0.90	1.79	2.69	4.5	13.5	44.9
				IFOV [mm]		0.2	0.3	0.5	0.9	1.9	3.8	5.6	9.4	28.1	93.8
f=25 mm Standard lens	25	13° 10° 16° 0.60 mrad	0.5 m	HFOV [m]	0.023	0.05	0.07	0.11	0.23	0.46	0.92	1.38	2.3	6.9	22.9
				VFOV [m]	0.017	0.03	0.05	0.09	0.17	0.35	0.69	1.04	1.7	5.2	17.3
				DFOV [m]	0.029	0.06	0.09	0.14	0.29	0.57	1.15	1.72	2.9	8.6	28.7
				IFOV [mm]	0.1	0.1	0.2	0.3	0.6	1.2	2.4	3.6	6.0	18.0	60.0
f=50 mm Telephoto lens	50	7° 5° 8° 0.30 mrad	1.5 m	HFOV [m]				0.06	0.11	0.23	0.46	0.69	1.1	3.4	11.5
				VFOV [m]				0.04	0.09	0.17	0.35	0.52	0.9	2.6	8.6
				DFOV [m]				0.07	0.14	0.29	0.57	0.86	1.4	4.3	14.4
				IFOV [mm]				0.2	0.3	0.6	1.2	1.8	3.0	9.0	30.0
f=75 mm Super telephoto lens	75	4° 3° 5° 0.20 mrad	2.0 m	HFOV [m]					0.08	0.15	0.31	0.46	0.8	2.3	7.6
				VFOV [m]					0.06	0.12	0.23	0.35	0.6	1.7	5.8
				DFOV [m]					0.10	0.19	0.38	0.57	1.0	2.9	9.6
				IFOV [mm]					0.2	0.4	0.8	1.2	2.0	6.0	20.0

¹⁾ TIM M-05 and TIM M-08 only available with OF25 lens | Please note: the camera provides 382 x 288 px in the 80 Hz mode

* Please note: The measurement accuracy of the camera may lie outside of the specifications for distances below the defined minimum measurement distance.

Sensors and Systems from Micro-Epsilon



Sensors and systems for displacement, distance and position



Sensors and measurement devices for non-contact temperature measurement



Measuring and inspection systems for metal strips, plastics and rubber



Optical micrometers and fiber optics, measuring and test amplifiers



Color recognition sensors, LED analyzers and inline color spectrometers

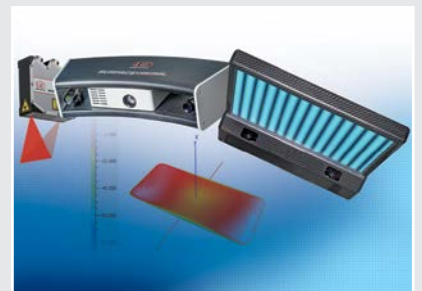

3D measurement technology for dimensional testing and surface inspection